

FEATURES

Small and thin

4 mm \times 4 mm \times 1.45 mm LFCSP package

2 mg resolution at 60 Hz

Wide supply voltage range: 2.4 V to 6 V

Low power: 340 μ A at $V_s = 2.4$ V (typ)

Good zero g bias stability

Good sensitivity accuracy

X-axis and Y-axis aligned to within 0.1° (typ)

BW adjustment with a single capacitor

Single-supply operation

10,000 g shock survival

Pb Free: Compatible with Sn/Pb and Pb-free solder processes

APPLICATIONS

Cost-sensitive motion- and tilt-sensing applications

Smart hand-held devices

Mobile phones

Sports and health-related devices

PC security and PC peripherals

GENERAL DESCRIPTION

The ADXL322 is a small, thin, low power, complete, dual-axis accelerometer with signal conditioned voltage outputs, which are all on a single monolithic IC. The product measures acceleration with a full-scale range of $\pm 2 g$ (typical). It can also measure both dynamic acceleration (vibration) and static acceleration (gravity).

The ADXL322's typical noise floor is $220 \mu g/\sqrt{\text{Hz}}$, which allows signals below 2 mg to be resolved in tilt-sensing applications using narrow bandwidths (<60 Hz).

The user selects the bandwidth of the accelerometer using capacitors C_X and C_Y at the X_{OUT} and Y_{OUT} pins. Bandwidths of 0.5 Hz to 2.5 kHz can be selected to suit the application.

The ADXL322 is available in a 4 mm \times 4 mm \times 1.45 mm, 16-lead, plastic LFCSP.

FUNCTIONAL BLOCK DIAGRAM

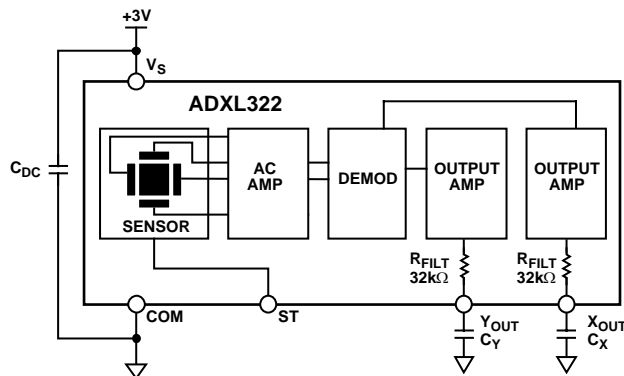

Figure 1.

Rev. 0

Information furnished by Analog Devices is believed to be accurate and reliable. However, no responsibility is assumed by Analog Devices for its use, nor for any infringements of patents or other rights of third parties that may result from its use. Specifications subject to change without notice. No license is granted by implication or otherwise under any patent or patent rights of Analog Devices. Trademarks and registered trademarks are the property of their respective owners.

TABLE OF CONTENTS

Specifications.....	3	Setting the Bandwidth Using C_X and C_Y	12
Absolute Maximum Ratings.....	4	Self-Test	12
ESD Caution.....	4	Design Trade-Offs for Selecting Filter Characteristics: The Noise/BW Trade-Off.....	12
Pin Configuration and Function Descriptions.....	5	Use with Operating Voltages Other than 3 V.....	13
Typical Performance Characteristics ($V_S = 3.0\text{ V}$)	7	Use as a Dual-Axis Tilt Sensor	13
Theory of Operation	11	Outline Dimensions	14
Performance	11	Ordering Guide	14
Applications.....	12		
Power Supply Decoupling	12		

REVISION HISTORY

6/05—Revision 0: Initial Version

SPECIFICATIONS

$T_A = 25^\circ\text{C}$, $V_S = 3\text{ V}$, $C_X = C_Y = 0.1\ \mu\text{F}$, Acceleration = 0 g, unless otherwise noted¹.

Table 1.

Parameter	Conditions	Min	Typ	Max	Unit
SENSOR INPUT					
Measurement Range	Each axis		± 2		g
Nonlinearity	% of full scale		± 0.2		%
Package Alignment Error			± 1		Degrees
Alignment Error	X sensor to Y sensor		± 0.1		Degrees
Cross-Axis Sensitivity			± 2		%
SENSITIVITY (RATIOMETRIC)²					
Sensitivity at X_{OUT} , Y_{OUT}	Each axis $V_S = 3\text{ V}$	378	420	462	mV/g
Sensitivity Change due to Temperature ³	$V_S = 3\text{ V}$		0.01		%/°C
ZERO g BIAS LEVEL (RATIOMETRIC)					
0 g Voltage at X_{OUT} , Y_{OUT}	Each axis $V_S = 3\text{ V}$	1.3	1.5	1.7	V
Initial 0 g Bias Deviation from Ideal			± 50		mg
0 g Offset Vs. Temperature			$< \pm 0.5$		mg/°C
NOISE PERFORMANCE					
Noise Density	at 25°C		220		$\mu\text{g}/\sqrt{\text{Hz}}$ rms
FREQUENCY RESPONSE⁴					
C_X , C_Y Range ⁵		0.002		10	μF
R_{FILT} Tolerance			$32 \pm 15\%$		k Ω
Sensor Resonant Frequency			5.5		kHz
SELF-TEST⁶					
Logic Input Low			0.6		V
Logic Input High			2.4		V
ST Input Resistance to Ground			50		k Ω
Output Change at X_{OUT} , Y_{OUT}	Self-test 0 to 1		125		mV
OUTPUT AMPLIFIER					
Output Swing Low	No load		0.2		V
Output Swing High	No load		2.7		V
POWER SUPPLY					
Operating Voltage Range		2.4		6	V
Quiescent Supply Current			0.45		mA
Turn-On Time ⁷			20		ms
TEMPERATURE					
Operating Temperature Range		-20		70	°C

¹ All minimum and maximum specifications are guaranteed. Typical specifications are not guaranteed.

² Sensitivity is essentially ratiometric to V_S . For $V_S = 2.7\text{ V}$ to 3.3 V , sensitivity is 138 mV/V/g to 142 mV/V/g typical.

³ Defined as the output change from ambient-to-maximum temperature or ambient-to-minimum temperature.

⁴ Actual frequency response controlled by user-supplied external capacitor (C_X , C_Y).

⁵ Bandwidth = $1/(2 \times \pi \times 32\text{ k}\Omega \times C)$. For C_X , $C_Y = 0.002\ \mu\text{F}$, bandwidth = 2500 Hz. For C_X , $C_Y = 10\ \mu\text{F}$, bandwidth = 0.5 Hz. Minimum/maximum values are not tested.

⁶ Self-test response changes cubically with V_S .

⁷ Larger values of C_X , C_Y increase turn-on time. Turn-on time is approximately $160 \times C_X$ or $C_Y + 4\text{ ms}$, where C_X , C_Y are in μF .

ADXL322

ABSOLUTE MAXIMUM RATINGS

Table 2.

Parameter	Rating
Acceleration (Any Axis, Unpowered)	10,000 g
Acceleration (Any Axis, Powered)	10,000 g
V _s	-0.3 V to +7.0 V
All Other Pins	(COM - 0.3 V) to (V _s + 0.3 V)
Output Short-Circuit Duration (Any Pin to Common)	Indefinite
Operating Temperature Range	-55°C to +125°C
Storage Temperature	-65°C to +150°C

Stresses above those listed under Absolute Maximum Ratings may cause permanent damage to the device. This is a stress rating only; functional operation of the device at these or any other conditions above those indicated in the operational section of this specification is not implied. Exposure to absolute maximum rating conditions for extended periods may affect device reliability.

ESD CAUTION

ESD (electrostatic discharge) sensitive device. Electrostatic charges as high as 4000 V readily accumulate on the human body and test equipment and can discharge without detection. Although this product features proprietary ESD protection circuitry, permanent damage may occur on devices subjected to high energy electrostatic discharges. Therefore, proper ESD precautions are recommended to avoid performance degradation or loss of functionality.



PIN CONFIGURATION AND FUNCTION DESCRIPTIONS

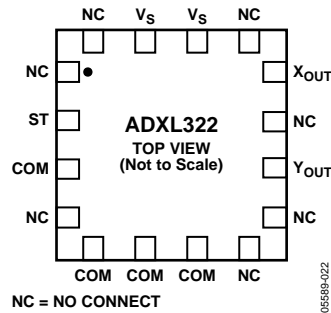

Figure 2. Pin Configuration

Table 3. Pin Function Descriptions

Pin No.	Mnemonic	Description
1	NC	Do Not Connect
2	ST	Self-Test
3	COM	Common
4	NC	Do Not Connect
5	COM	Common
6	COM	Common
7	COM	Common
8	NC	Do Not Connect
9	NC	Do Not Connect
10	Y _{OUT}	Y-Channel Output
11	NC	Do Not Connect
12	X _{OUT}	X-Channel Output
13	NC	Do Not Connect
14	V _S	2.4 V to 6 V
15	V _S	2.4 V to 6 V
16	NC	Do Not Connect

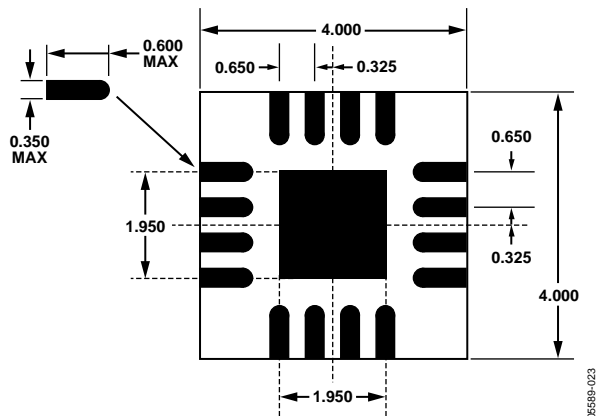

Figure 3. 4 mm x 4 mm 16-pad LFCSP Recommended Pad Layout

ADXL322

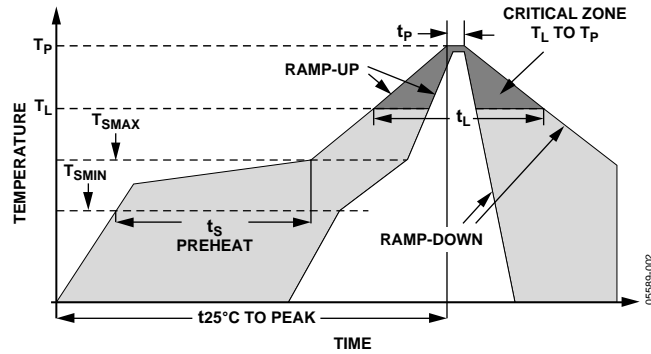

Figure 4. Recommended Soldering Profile

Table 4. Recommended Soldering Profile

Profile Feature	Sn63/Pb37	Pb-Free
Average Ramp Rate (T_L to T_P)	3°C/sec max	3°C/sec max
Preheat		
Minimum Temperature (T_{SMIN})	100°C	150°C
Minimum Temperature (T_{SMAX})	150°C	200°C
Time (T_{SMIN} to T_{SMAX}), t_s	60 sec – 120 sec	60 sec – 150 sec
T_{SMAX} to T_L		
Ramp-Up Rate	3°C/sec	3°C/sec
Time Maintained Above Liquidous (T_L)		
Liquidous Temperature (T_L)	183°C	217°C
Time (t_L)	60 sec – 150 sec	60 sec – 150 sec
Peak Temperature (T_P)	240°C + 0°C/-5°C	260°C + 0°C/-5°C
Time within 5°C of Actual Peak Temperature (t_p)	10 sec – 30 sec	20 sec – 40 sec
Ramp-Down Rate	6°C/sec max	6°C/sec max
Time 25°C to Peak Temperature	6 min max	8 min max

TYPICAL PERFORMANCE CHARACTERISTICS ($V_s = 3.0\text{ V}$)

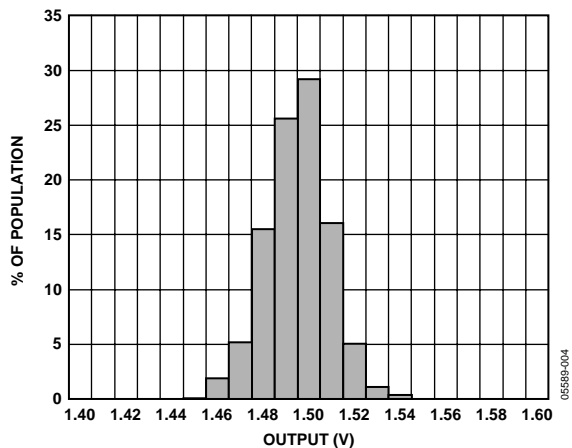

Figure 5. X-axis Zero g Bias at 25°C

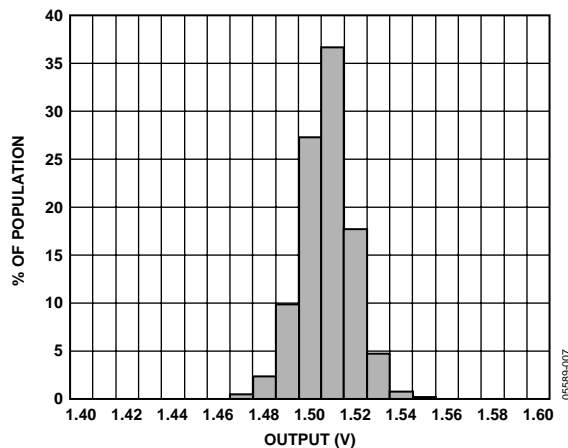

Figure 8. Y-axis Zero g Bias at 25°C

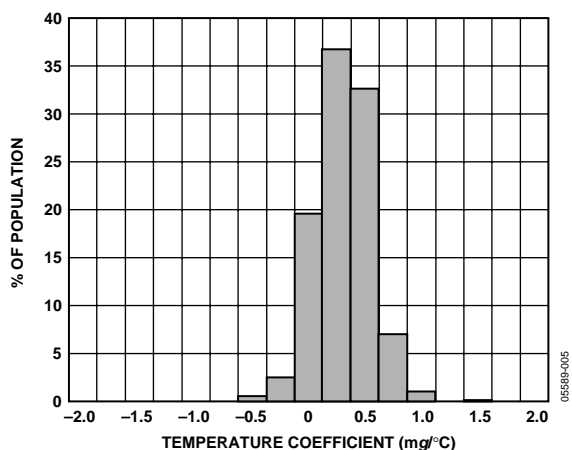

Figure 6. X-axis Zero g Bias Temperature Coefficient

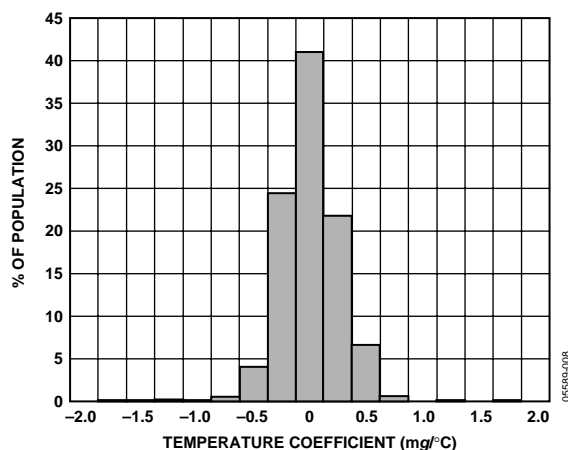

Figure 9. Y-axis Zero g Bias Temperature Coefficient

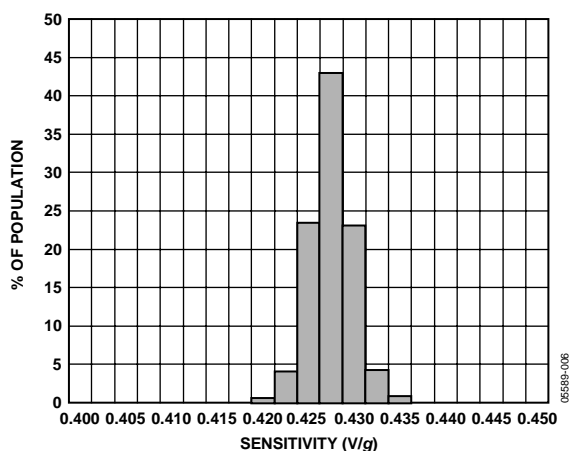

Figure 7. X-axis Sensitivity at 25°C

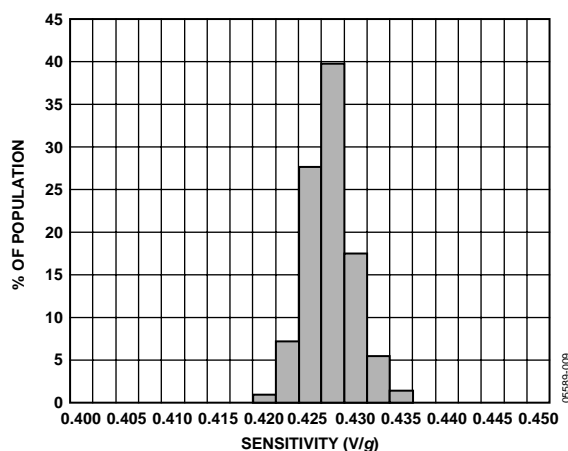

Figure 10. Y-axis Sensitivity at 25°C

ADXL322

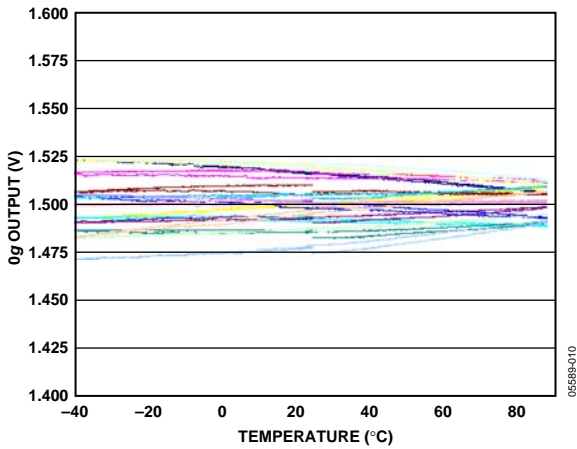

Figure 11. Zero g Bias vs. Temperature—Parts Soldered to PCB

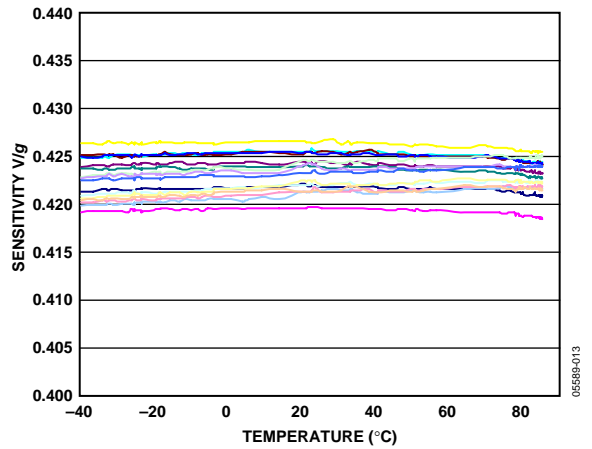

Figure 14. Sensitivity vs. Temperature—Parts Soldered to PCB

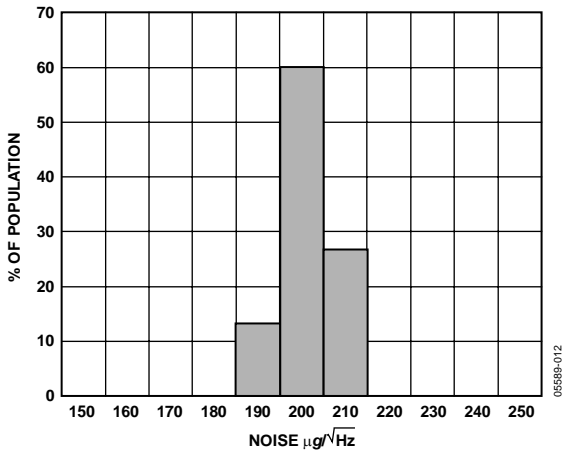

Figure 12. X-Axis Noise Density at 25°C

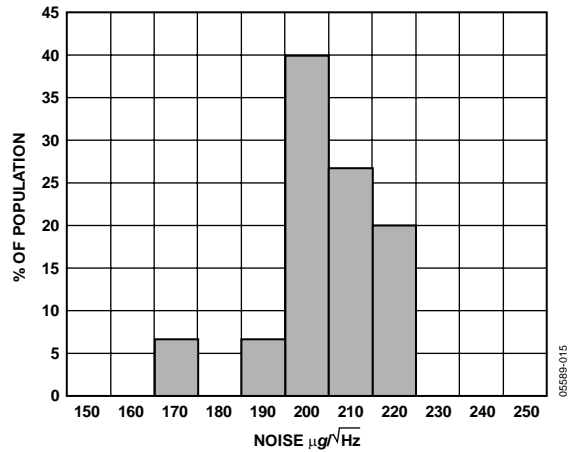

Figure 15. Y-Axis Noise Density at 25°C

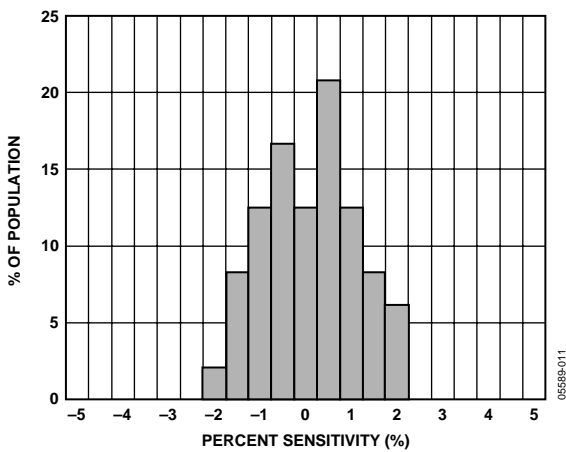

Figure 13. Z vs. X Cross-Axis Sensitivity

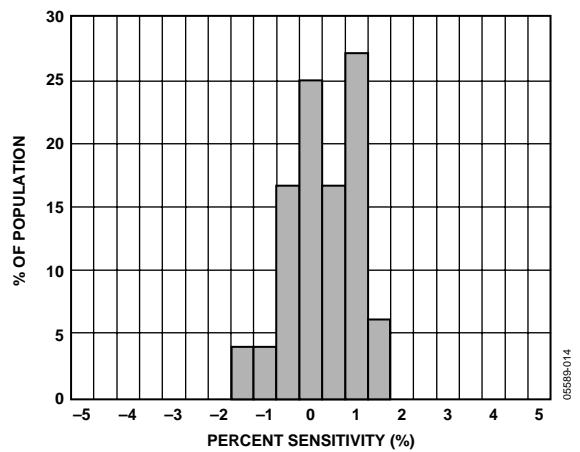

Figure 16. Z vs. Y Cross-Axis Sensitivity

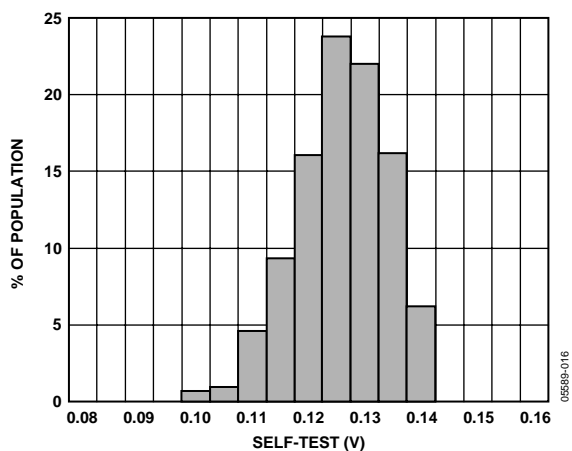

Figure 17. X-Axis Self-Test Response at 25°C

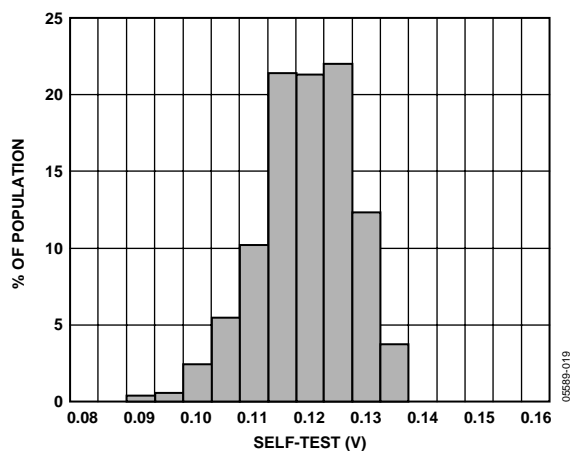

Figure 19. Y-Axis Self-Test Response at 25°C

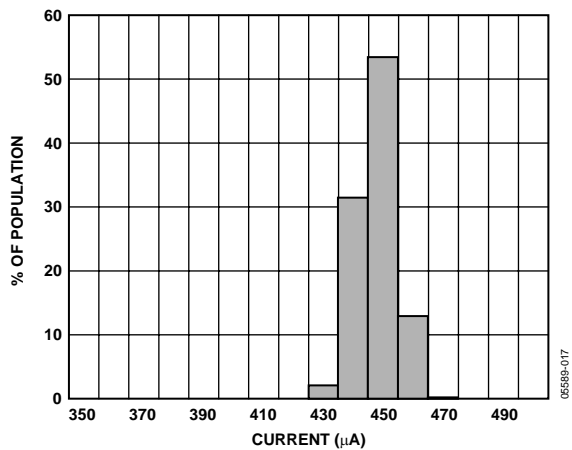

Figure 18. Supply Current at 25°C

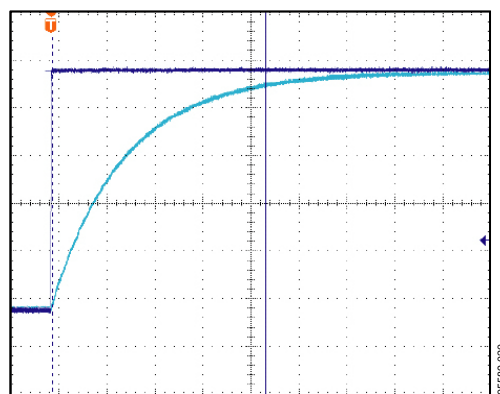

Figure 20. Turn-On Time— $C_x, C_y = 0.1 \mu F$, Time Scale = 2 ms/DIV

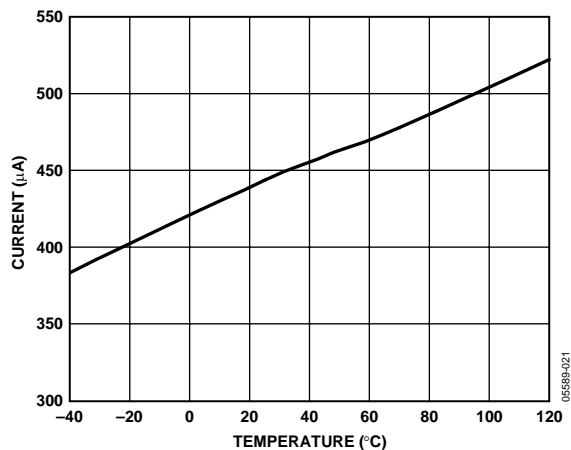

Figure 21. Supply Current vs. Temperature $V_s=3V$

ADXL322

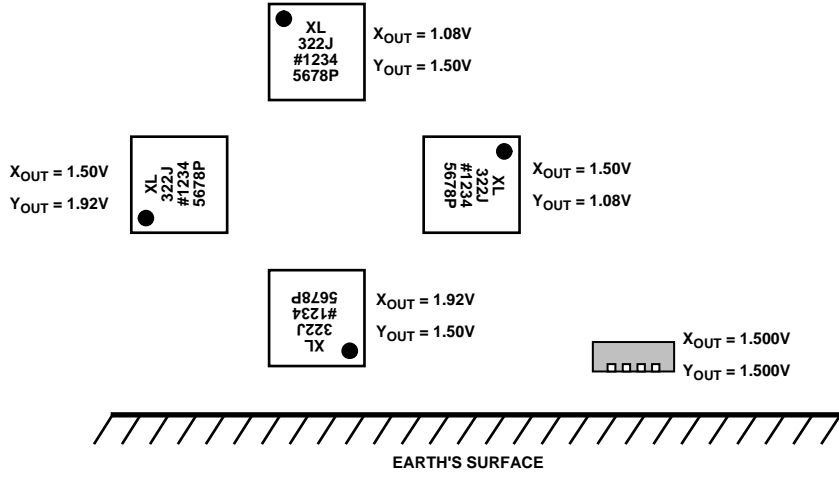

Figure 22. Output Response vs. Orientation

056888-018

THEORY OF OPERATION

The ADXL322 is a complete acceleration measurement system on a single monolithic IC. The ADXL322 has a measurement range of ± 2 g. It contains a polysilicon surface micromachined sensor and signal conditioning circuitry to implement an open-loop acceleration measurement architecture. The output signals are analog voltages that are proportional to acceleration. The accelerometer measures static acceleration forces, such as gravity, which allows it to be used as a tilt sensor.

The sensor is a polysilicon surface-micromachined structure built on top of a silicon wafer. Polysilicon springs suspend the structure over the surface of the wafer and provide a resistance against acceleration forces. Deflection of the structure is measured using a differential capacitor that consists of independent fixed plates and plates attached to the moving mass. The fixed plates are driven by 180° out-of-phase square waves. Acceleration deflects the beam and unbalances the differential capacitor, resulting in an output square wave whose amplitude is proportional to acceleration. Phase-sensitive demodulation techniques are then used to rectify the signal and determine the direction of the acceleration.

The demodulator's output is amplified and brought off-chip through a $32\text{ k}\Omega$ resistor. The user then sets the signal bandwidth of the device by adding a capacitor. This filtering improves measurement resolution and helps prevent aliasing.

PERFORMANCE

Rather than using additional temperature compensation circuitry, innovative design techniques were used to ensure built-in high performance. As a result, there is neither quantization error nor nonmonotonic behavior, and temperature hysteresis is very low (typically less than 5 mg over the -20°C to $+70^\circ\text{C}$ temperature range).

Figure 11 shows the zero g output performance of eight parts (X- and Y-axis) over a -20°C to $+70^\circ\text{C}$ temperature range.

Figure 14 demonstrates the typical sensitivity shift over temperature for supply voltages of 3 V. This is typically better than $\pm 1\%$ over the -20°C to $+70^\circ\text{C}$ temperature range.

ADXL322

APPLICATIONS

POWER SUPPLY DECOUPLING

For most applications, a single 0.1 μF capacitor, C_{DC} , adequately decouples the accelerometer from noise on the power supply. However, in some cases, particularly where noise is present at the 140 kHz internal clock frequency (or any harmonic thereof), noise on the supply can cause interference on the ADXL322 output. If additional decoupling is needed, a 100 Ω (or smaller) resistor or ferrite bead can be inserted in the supply line. Additionally, a larger bulk bypass capacitor (in the 1 μF to 4.7 μF range) can be added in parallel to C_{DC} .

SETTING THE BANDWIDTH USING C_X AND C_Y

The ADXL322 has provisions for band-limiting the X_{OUT} and Y_{OUT} pins. Capacitors must be added at these pins to implement low-pass filtering for antialiasing and noise reduction. The equation for the 3 dB bandwidth is

$$F_{-3\text{dB}} = 1/(2\pi(32\text{ k}\Omega) \times C_{(X,Y)})$$

or more simply,

$$F_{-3\text{dB}} = 5\ \mu\text{F}/C_{(X,Y)}$$

The tolerance of the internal resistor (R_{FILT}) typically varies as much as $\pm 15\%$ of its nominal value (32 k Ω), and the bandwidth varies accordingly. A minimum capacitance of 2000 pF for C_X and C_Y is required in all cases.

Table 5. Filter Capacitor Selection, C_X and C_Y

Bandwidth (Hz)	Capacitor (μF)
1	4.7
10	0.47
50	0.10
100	0.05
200	0.027
500	0.01

SELF-TEST

The ST pin controls the self-test feature. When this pin is set to V_S , an electrostatic force is exerted on the accelerometer beam. The resulting movement of the beam allows the user to test if the accelerometer is functional. The typical change in output is 300 mg (corresponding to 125 mV). This pin can be left open-circuit or connected to common (COM) in normal use.

The ST pin should never be exposed to voltages greater than $V_S + 0.3\text{ V}$. If this cannot be guaranteed due to the system design (for instance, if there are multiple supply voltages), then a low V_F clamping diode between ST and V_S is recommended.

DESIGN TRADE-OFFS FOR SELECTING FILTER CHARACTERISTICS: THE NOISE/BW TRADE-OFF

The accelerometer bandwidth selected ultimately determines the measurement resolution (smallest detectable acceleration). Filtering can be used to lower the noise floor, which improves the resolution of the accelerometer. Resolution is dependent on the analog filter bandwidth at X_{OUT} and Y_{OUT} .

The output of the ADXL322 has a typical bandwidth of 2.5 kHz. To limit aliasing errors, the user must filter the signal at this point. The analog bandwidth must be no more than half the A/D sampling frequency to minimize aliasing. The analog bandwidth can be further decreased to reduce noise and improve resolution.

The ADXL322 noise has the characteristics of white Gaussian noise, which contributes equally at all frequencies and is described in terms of $\mu\text{g}/\sqrt{\text{Hz}}$ (the noise is proportional to the square root of the accelerometer's bandwidth). The user should limit bandwidth to the lowest frequency needed by the application in order to maximize the resolution and dynamic range of the accelerometer.

With the single-pole, roll-off characteristic, the typical noise of the ADXL322 is determined by

$$\text{rmsNoise} = (220\ \mu\text{g}/\sqrt{\text{Hz}}) \times (\sqrt{\text{BW} \times 1.6})$$

At 100 Hz bandwidth the noise will be

$$\text{rmsNoise} = (220\ \mu\text{g}/\sqrt{\text{Hz}}) \times (\sqrt{100 \times 1.6}) = 2.8\ \text{mg}$$

Often, the peak value of the noise is desired. Peak-to-peak noise can only be estimated by statistical methods. Table 6 is useful for estimating the probabilities of exceeding various peak values, given the rms value.

Table 6. Estimation of Peak-to-Peak Noise

Peak-to-Peak Value	% of Time That Noise Exceeds Nominal Peak-to-Peak Value
2 \times rms	32
4 \times rms	4.6
6 \times rms	0.27
8 \times rms	0.006

Peak-to-peak noise values give the best estimate of the uncertainty in a single measurement. Table 7 gives the typical noise output of the ADXL322 for various C_X and C_Y values.

Table 7. Filter Capacitor Selection (C_X , C_Y)

Bandwidth (Hz)	C_X , C_Y (μ F)	RMS Noise (mg)	Peak-to-Peak Noise Estimate (mg)
10	0.47	0.9	5.3
50	0.1	2	11.8
100	0.047	2.8	16.7
500	0.01	6.2	37.3

USE WITH OPERATING VOLTAGES OTHER THAN 3 V

The ADXL322 is tested and specified at $V_S = 3$ V; however, this part can be powered with V_S as low as 2.4 V or as high as 6 V. Note that some performance parameters change as the supply voltage is varied.

The ADXL322 output is ratiometric, so the output sensitivity (or scale factor) varies proportionally to supply voltage. At $V_S = 5$ V, the output sensitivity is typically 750 mV/g. At $V_S = 2.4$ V, the output sensitivity is typically 335 mV/g.

The zero g bias output is also ratiometric, so the zero g output is nominally equal to $V_S/2$ at all supply voltages.

The output noise is not ratiometric but is absolute in volts; therefore, the noise density decreases as the supply voltage increases. This is because the scale factor (mV/g) increases while the noise voltage remains constant. At $V_S = 5$ V, the noise density is typically 150 μ g/ \sqrt Hz, while at $V_S = 2.4$ V, the noise density is typically 300 μ g/ \sqrt Hz.

Self-test response in g is roughly proportional to the square of the supply voltage. However, when ratiometricity of sensitivity is factored in with supply voltage, the self-test response in volts is roughly proportional to the cube of the supply voltage. For example, at $V_S = 5$ V, the self-test response for the ADXL322 is approximately 610 mV. At $V_S = 2.4$ V, the self-test response is approximately 59 mV.

The supply current decreases as the supply voltage decreases. Typical current consumption at $V_S = 5$ V is 700 μ A, and typical current consumption at $V_S = 2.4$ V is 340 μ A.

USE AS A DUAL-AXIS TILT SENSOR

Tilt measurement is one of the ADXL322’s most popular applications. An accelerometer uses the force of gravity as an input vector to determine the orientation of an object in space.

An accelerometer is most sensitive to tilt when its sensitive axis is perpendicular to the force of gravity (that is, when the package is parallel to the earth’s surface). At this orientation, the accelerometer’s sensitivity to changes in tilt is highest. When the accelerometer is oriented on axis to gravity (near its +1 g or -1 g reading), the change in output acceleration per degree of tilt is negligible. When the accelerometer is perpendicular to gravity, its output changes nearly 17.5 mg per degree of tilt. At 45°, its output changes at only 12.2 mg per degree of tilt, and resolution declines.

Converting Acceleration to Tilt

When the accelerometer is oriented so both its X-axis and Y-axis are parallel to the earth’s surface, it can be used as a 2-axis tilt sensor with both a roll axis and a pitch axis. Once the output signal from the accelerometer has been converted to an acceleration that varies between -1 g and +1 g, the output tilt in degrees is calculated as

$$PITCH = ASIN(A_x/1 g)$$

$$ROLL = ASIN(A_y/1 g)$$

Be sure to account for overranges. It is possible for the accelerometers to output a signal greater than ± 1 g due to vibration, shock, or other accelerations.

ADXL322

OUTLINE DIMENSIONS

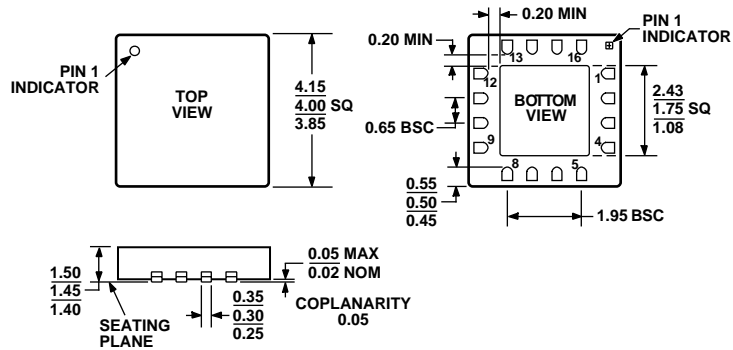

Figure 23. 16-Lead Lead Frame Chip Scale Package [LFCSP_LQ]
 4 mm × 4 mm Body, Thick Quad
 (CP-16-5)
 Dimensions shown in millimeters

ORDERING GUIDE

Model	Measurement Range	Specified Voltage (V)	Temperature Range	Package Description	Package Option
ADXL322JCP ¹	±2 g	3	-20°C to +70°C	16-Lead LFCSP_LQ	CP-16-5
ADXL322JCP-REEL ¹	±2 g	3	-20°C to +70°C	16-Lead LFCSP_LQ	CP-16-5
ADXL322EB				Evaluation Board	

¹ Lead finish—Matte tin.

NOTES

ADXL322

NOTES